

# DG500

## Digital Keypad & Proximity Reader

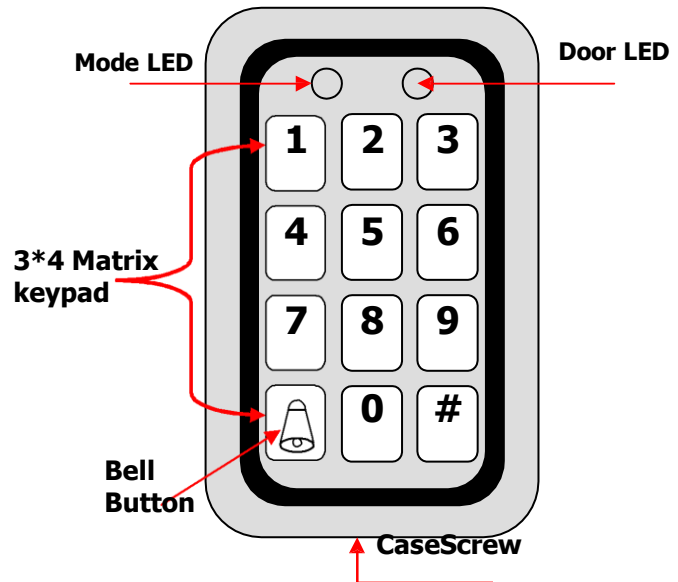

### KEY FEATURES:

- Built in Proximity Reader
- Built in Keypad for Code entry
- 500 user codes
- Illuminated Keys
- Auxiliary Input & Auxiliary Output
- Individually programmable Output
- 12vDC operation
- 2 Open door Modes (code only – card only)
- 1 Secure door mode (card & pin)
- Internal & external use
- Metal case construction

### Technical Specification

Operating Voltage: 12vDC  
Current: 130mA

### Built –in Proximity reader

Compatible Cards All 26-Bit EM Cards.

### Size

120 Long x 76 Wide x 27 High Dim in mm



SPECIALIZED SECURITY PRODUCTS Ltd















Camfield House, Avenue One, Letchworth Garden City, Hertfordshire SG6 2WW  
Tele: 01763 274223

Email: [sales@specialized-security.co.uk](mailto:sales@specialized-security.co.uk)













Web: [www.specialized-security.co.uk](http://www.specialized-security.co.uk)





## DG500 KEYPAD PROGRAMMING INSTRUCTIONS

### (How to programme 4 digit PIN NUMBER)

	LED Sequence	
Apply 12vDC LH Green -----		
Press # (2 seconds) RH light turns Red -----		
Enter 1234 RH lights turns-----		
Enter 7 RH light turns -----		
Create a user code 3 figures (001 to 500) LH flashing (Green) RH (Red)		
Create a pin for user LH turns Green RH turns Red -----		
Press # (2 seconds) LH turns Green -----		















### (How to Delete Pin)













	LED Sequence	
Keypad powered with 12vDC LH light Green -----		
Press # (2 seconds) RH light turns Red -----		
Enter 1234 LH light turns Green -----		
Enter 8 Both LH & RH lights turn Red -----		
Enter 3 digit user code (one to be removed) LH flashing Red		
Enter 1234 to confirm LH light turns Green -----		





Index	
LED out -----	
LED Green solid -----	
LED Green flashing --	
LED Red solid -----	
LED Red flashing -----	



## DG500 KEYPAD PROGRAMMING INSTRUCTIONS

<b>(How to Insert Proximity Card EM Type)</b>	LED Sequence
Apply 12vDC LH Green -----	 
Press # (2 seconds) RH light turns Red -----	 
Enter 1234 RH lights turns Green -----	 
Enter 7 RH light turns Red -----	 
Create a user code 3 figures (001 to 500) LH flashing (Green) RH (Red)	 
Show EM Card to Keypad LH Green RH Red -----	 
Press # (2 seconds) LH light turns Green -----	 











<b>(How to Delete Card)</b>	LED Sequence
Keypad powered with 12vDC LH light Green -----	 
Press # (2 seconds) RH light turns Red -----	 
Enter 1234 LH light turns Green -----	 
Enter 8 Both LH & RH lights turn Red -----	 
Enter 3 digit user code (one to be removed) LH flashing Red	 
Enter 1234 to confirm LH light turns Green -----	 

Index	
LED out -----	
LED Green solid -----	
LED Green flashing -----	
LED Red solid -----	
LED Red flashing -----	













## DG500 KEYPAD PROGRAMMING INSTRUCTIONS

### How to change Relay One





	LED Sequence	
Apply 12vDc – LH Green -----		
Press # (2 Seconds) RH turns Red-----		
Enter 1234 RH turns green -----		
Enter 6 LH flashes Green RH Green -----		
Enter 00 + 01-99 sec bleeps twice LH turns green -----		

**00** denotes relay 1, the next 2 digits sets time in seconds.

### How to change Relay Two

	LED Sequence	
Apply 12vDc – LH Green -----		
Press # (2 Seconds) RH turns Red-----		
Enter 1234 RH turns green -----		
Enter 6 LH flashes Green RH Green -----		
Enter 20 + 00-99 sec bleeps twice LH turns green -----		











**20** denotes relay 2, the next 2 digits sets time in seconds. For latch mode set time to 00 (e.g., enter 2000)

Index	
LED out -----	
LED Green solid -----	
LED Green flashing --	
LED Red solid -----	
LED Red flashing -----	













**DG500 KEYPAD PROGRAMMING INSTRUCTIONS**  
**OTHER INSTRUCTIONS YOU MAY NEED**





**FACTORY RESET**

	LED Sequence	
Apply 12vDC LH LED is Green -----		
Enter # (2 seconds) RH LED turns RED -----		
Enter 1234 RH LED turns Green -----		
Enter 0 LH & RH LED turn RED both flashing-----		
Enter 1234 LH LED turns Green -----		

**LOCK STRIKE & AUXILIARY RELAY CODE ASSIGNMENT**

	LED Sequence	
Apply 12vDc – LH Green -----		
Press # (2 Seconds) RH turns Red-----		
Enter 1234 RH turns green -----		
Enter 9 LH flashes Green RH Green -----		
Enter 3 digit user code you need to assign too -----		

Enter assignment digit for current User Slot  
 ( 1 ) lock strike relay  
 ( 2 ) Auxiliary relay  
 ( 3 ) lock & Auxiliary

Index	
LED out -----	
LED Green solid -----	
LED Green flashing --	
LED Red solid -----	
LED Red flashing -----	

















DG500 KEYPAD PROGRAMMING INSTRUCTIONS















**PROGRAMMING CARD & PIN FACILITY**

PLEASE NOTE CARD AND PIN WILL ONLY WORK IN **SECURE MODE**

**(How to Insert Proximity Card EM Type)**

	LED Sequence
Apply 12vDC LH Green -----	 
Press # (2 seconds) RH light turns Red -----	 
Enter 1234 RH lights turns Green -----	 
Enter 7 RH light turns Red -----	 
Create a user code 3 figures (001 to 500) LH flashing (Green) RH (Red)	 
Show EM Card to Keypad LH Green RH Red -----	 
Press # (2 seconds) LH light turns Green -----	 

**(How to programme 4 digit PIN NUMBER)**

	LED Sequence
Apply 12vDC LH Green -----	 
Press # (2 seconds) RH light turns Red -----	 
Enter 1234 RH lights turns-----	 
Enter 7 RH light turns -----	 
Create a user code 3 figures (001 to 500) LH flashing (Green) RH (Red)	 
Create a pin for user LH turns Green RH turns Red -----	 
Press # (2 seconds) LH turns Green -----	 









**TO SWITCH KEYPAD FROM NORMAL MODE TO SECURE MODE**





**Keypad in normal mode**

**#3838#**

**revert back to normal mode**

**#3838#**

Index	
LED out -----	
LED Green solid -----	
LED Green flashing -	
LED Red solid -----	
LED Red flashing -----	



Programme DG500 latching mode.

To use latching mode, you must use Auxiliary relay 2

Stage1

# for 2 seconds till red light comes on

1234

7

Create user code 3 figures (**001 to 500**)

Create pin for user 4 digit (**not 1234**)

# till red light goes off

Stage 2

# for 2 seconds till red light comes on

1234

9

Enter user code 3 figure number in stage 1

2

# till red light goes off

Stage 3

# till red light comes on

1234

6

2000

# till red light goes off

When 4 figure number is put into keypad relay 2 opens

Relay is closed by putting on 4 figure number in again.



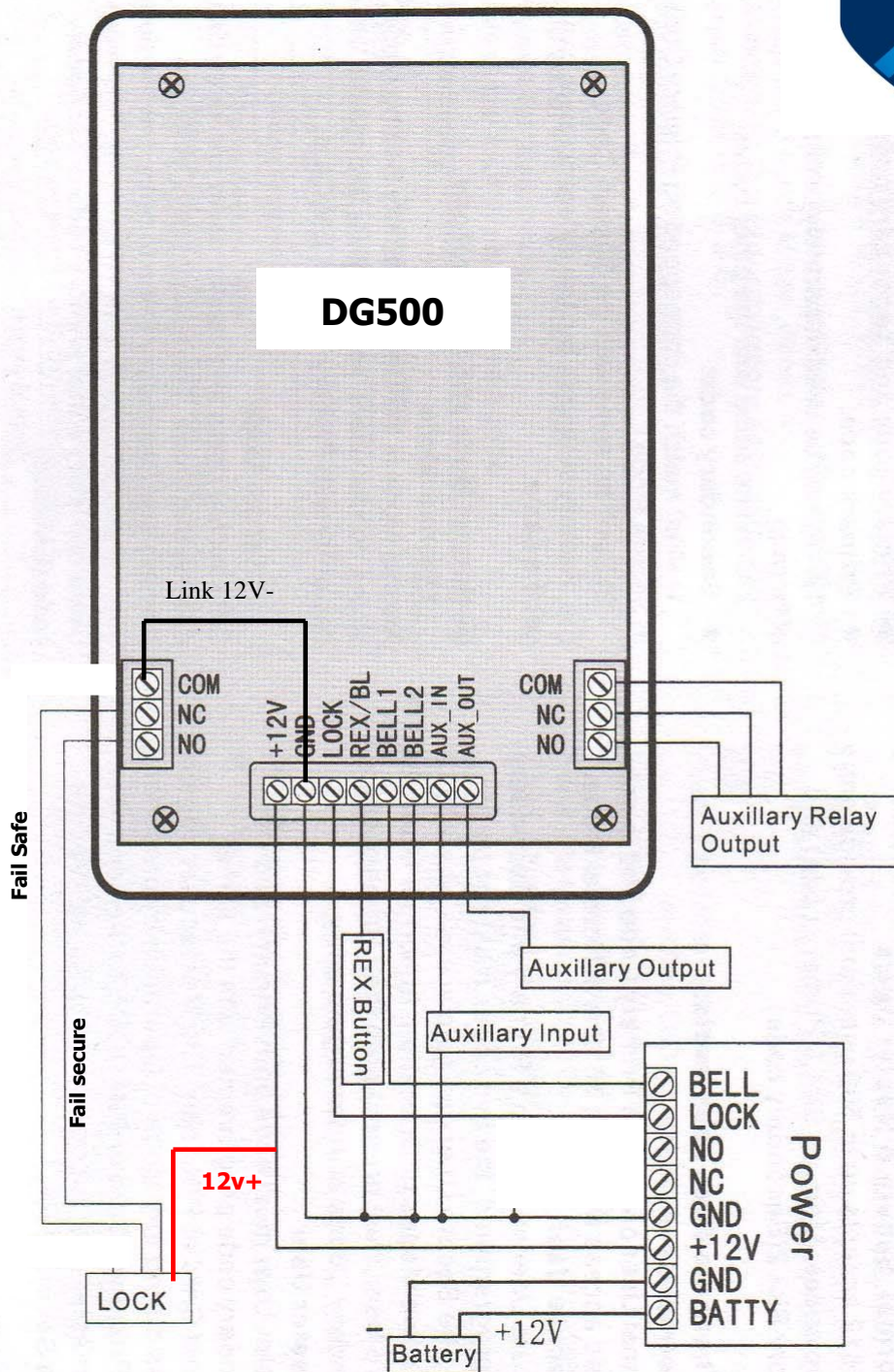



# Latching Wiring

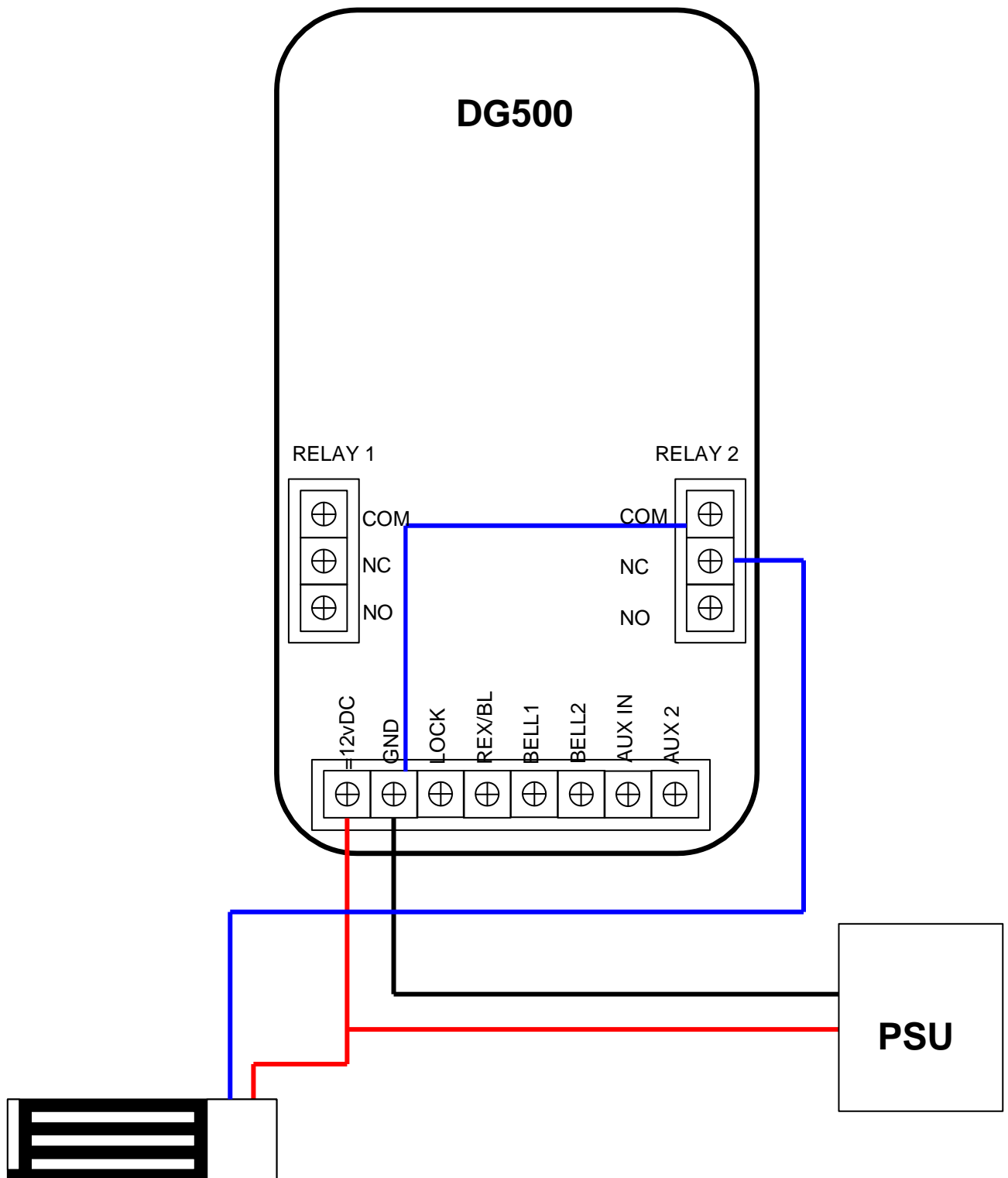

Latching mode only through relay 2.

# Magnet Wiring

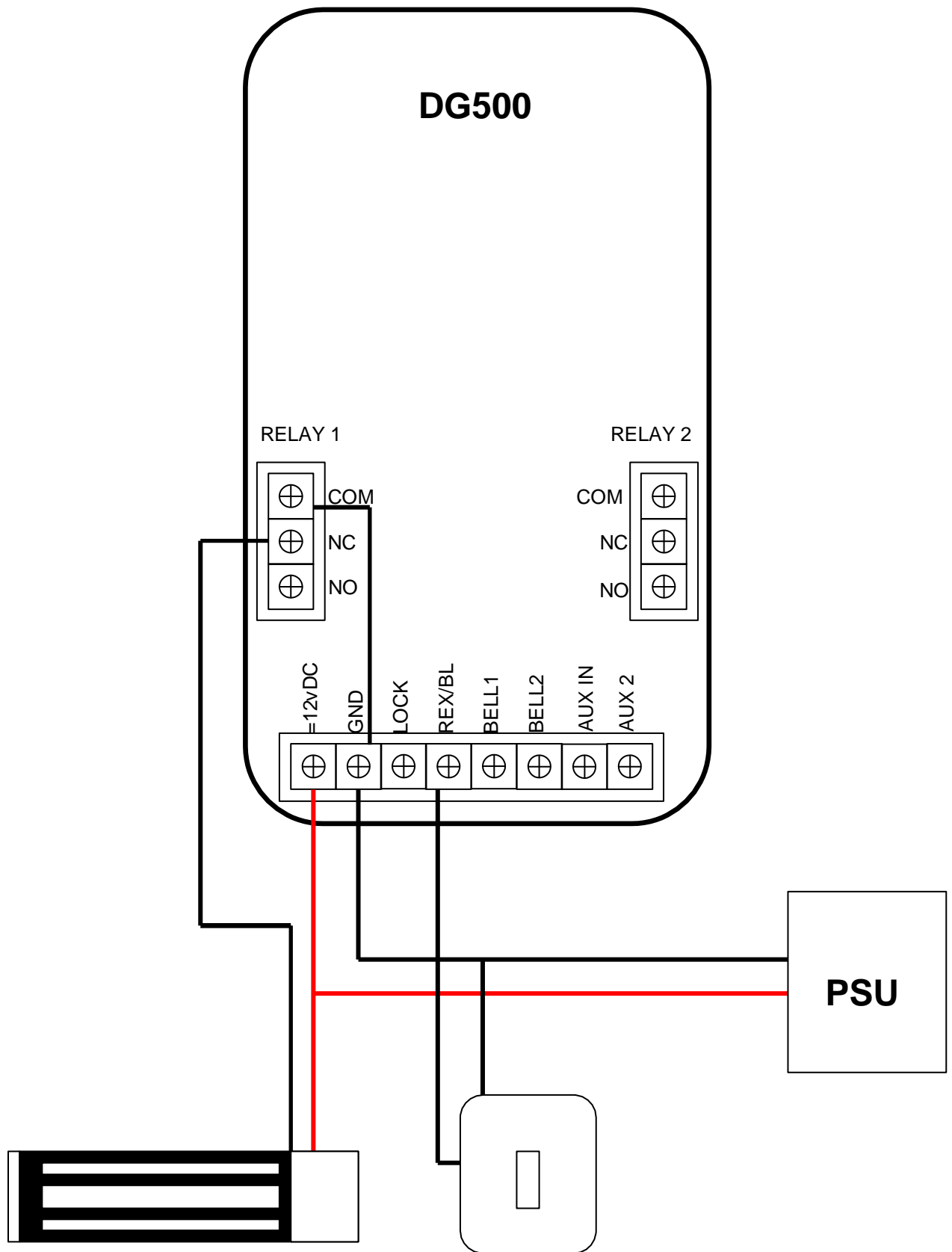

# Wiring Fail Secure

